

Clinical Psychology



2

"I want to say that the treatments we have for depression are appalling. They're not very effective. They're extremely costly. They come with innumerable side effects. They're a disaster.

But I am so grateful that I live now and not 50 years ago, when there would have been almost nothing to be done.

I hope that 50 years hence, people will hear about my treatments and be appalled that anyone endured such primitive science."

Andrew Solomon, TEDtalk

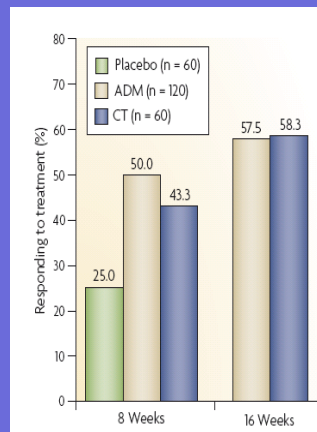

DeRubeis et al.,
Arch Gen Psychiatry 2005

4

The New York Times

June 7, 2005

Most Will Be Mentally ill at Some Point

More than half of Americans will develop a mental illness at some point in their lives, often beginning in childhood or adolescence, researchers have found in a survey that experts say will have wide-ranging implications for the practice of psychiatry.

BBC Sign in News Sport Weather Shop Reel Travel Mo

NEWS

Home Video World UK Business Tech Science Stories Entertainment & Arts

Education & Family

Rising numbers of stressed students seek help

By Sean Coughlan
Education correspondent

© 30 September 2015

f t e Share

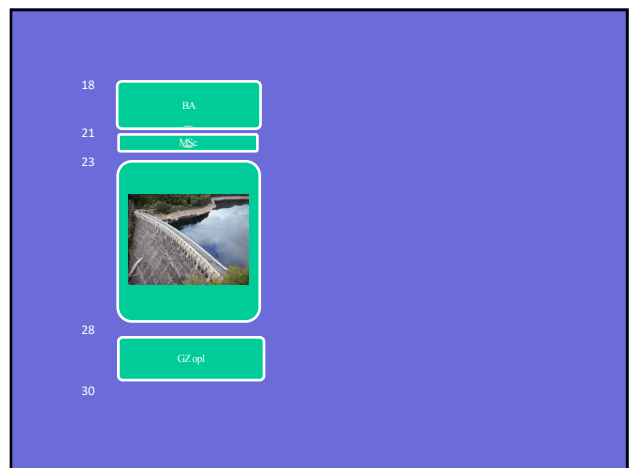
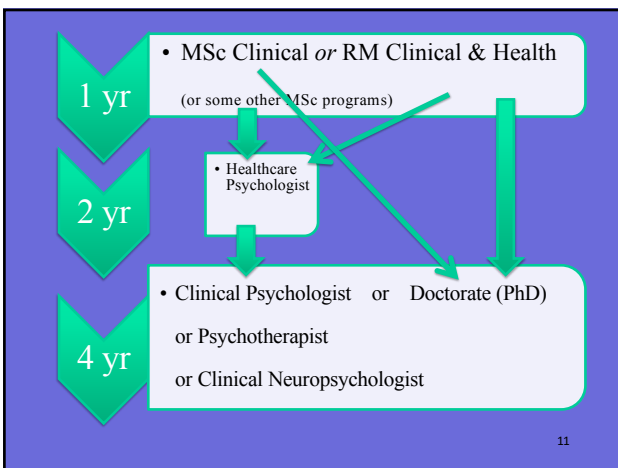
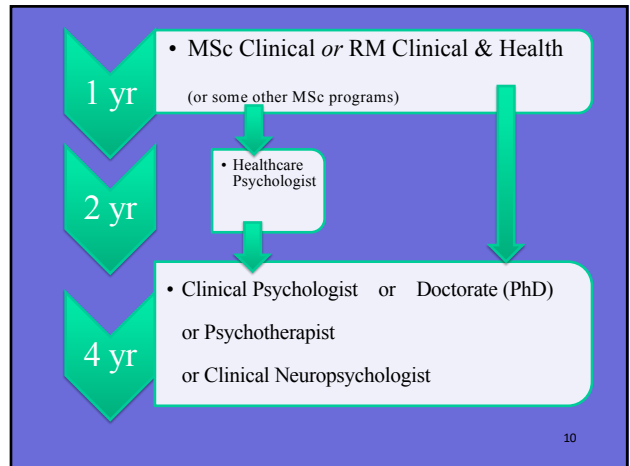
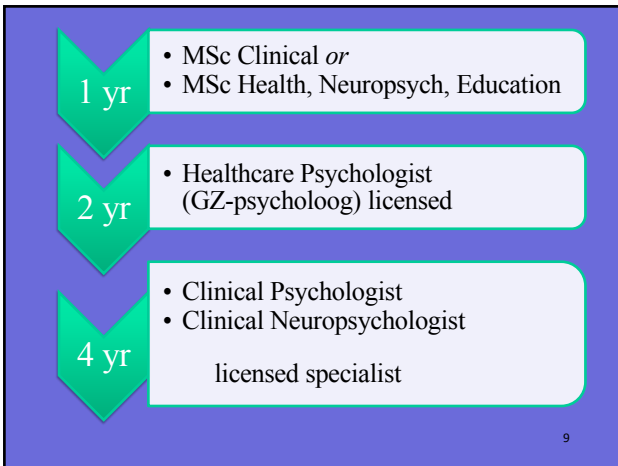
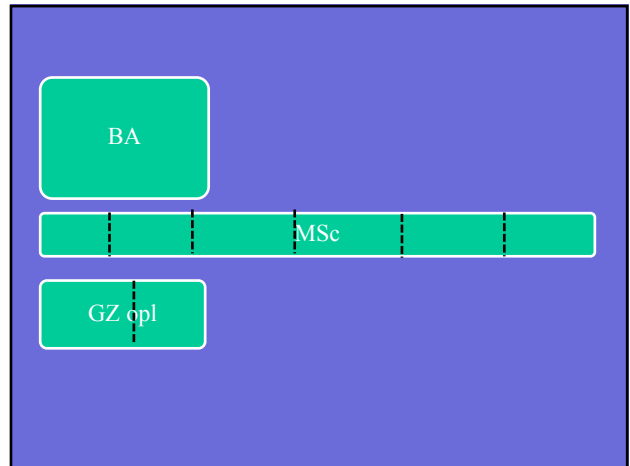
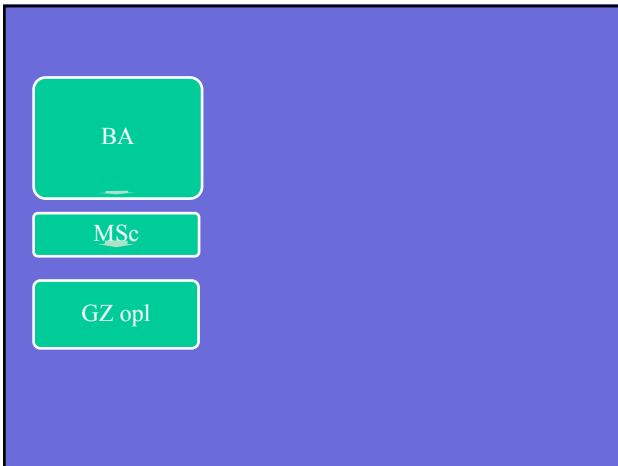

Curriculum 60 ECTS: Two options

Mandatory:

| | |
|---------------|-------|
| 4 Courses | 20 EC |
| Master thesis | 20 EC |

| | |
|------------|-------|
| Internship | 20 EC |
|------------|-------|

or

| | |
|----------------------|-------|
| Internship | 10 EC |
| + 2 elective courses | 10 EC |

13

Clinical Psychology

Course content (20 EC)

Acquiring advance *knowledge and skills* on:

- Clinical Interviewing and Assessment
- Basic Therapeutic Skills
- Cognitive Behavioral Interventions
- Experimental Clinical Psychology: Treatment research

Scientist-practitioner model:

- Skills training
- Theory of psychopathology and psychotherapy
- Research

Clinical Psychology

20 EC mandatory courses
20 EC thesis
20 EC internship *or* 10 EC internship + 10 EC electives

Example electives:

- Eating disorders
- E-health

Internships:

20 ECTS at mental health institutions (NL or abroad)
10 ECTS internal internship (research or counseling)

Clinical Psychology

Career prospects & Internships

- Mental Health Care services (GGZ)
 - Primary care
 - Secondary care
- General Hospitals
- Prisons
- Private practice
- Health Care policy
- Psychological training and coaching
- Research



Why Clinical Psychology at Leiden University?

- Combining skills training, theory, research skills
- Taught by (inter)nationally recognized faculty
- Faculty is mix of clinician-scientists and experimental psychologist with clinical interest
- Scientist-practitioner model
- Good connections with local mental health centers.
- Start of own treatment facility in 2017.
- Cutting-edge research program.

17

Depression Cognition Psychotherapy
Psychopharmacology Clinical Trials Schizophrenia
Anxiety Hypnosis Personality disorders
Psychopathy Neuroimaging Child Abuse E-
Health Nutrition

18